

APPLE MONITOR II
MODEL A2M2010

CMT9-1



CMT9-1

APPLE MONITOR II
MODEL A2M2010

SAFETY PRECAUTIONS

See page 26.

PRELIMINARY SERVICE CHECKS

ENCLOSED

INDEX

	Page		Page
Disassembly Instructions	27	Photos (Continued)	
GridTrace Location Guide		Main Board	5 thru 10, 19 thru 24
Main Board	11,12,13	Quick-Checks Troubleshooting	
IC Pinouts and Terminal Guides	28	Main Board	4,25
Miscellaneous Adjustments	18	Safety Precautions	26
Parts List	14,15,16	Schematic	2
Photos		Servicing in the Field	27
AC Input Board	3	Test Equipment	17
Cabinet-Rear View	18	Troubleshooting	17
CRT Board	3		

SAMS™ Howard W. Sams & Co.
4300 West 62nd Street, P.O. Box 7092, Indianapolis, Indiana 46206 U.S.A.

The listing in any available replacement part herein does not constitute in any case a recommendation, warranty or guaranty by Howard W. Sams & Co., Inc., as to the quality and suitability of such replacement part. The numbers of these parts have been compiled from information furnished to Howard W. Sams & Co., Inc., by the manufacturers of the particular type of replacement part listed.

Reproduction or use, without express permission, of editorial or pictorial content, in any manner, is prohibited. No patent liability is assumed with respect to the use of the information contained herein.

© 1986 Howard W. Sams & Co.

4300 West 62nd Street, P.O. Box 7092, Indianapolis, Indiana 46206 U.S.A.
Printed in U.S. of America. 86CM14979 DATE 4-86

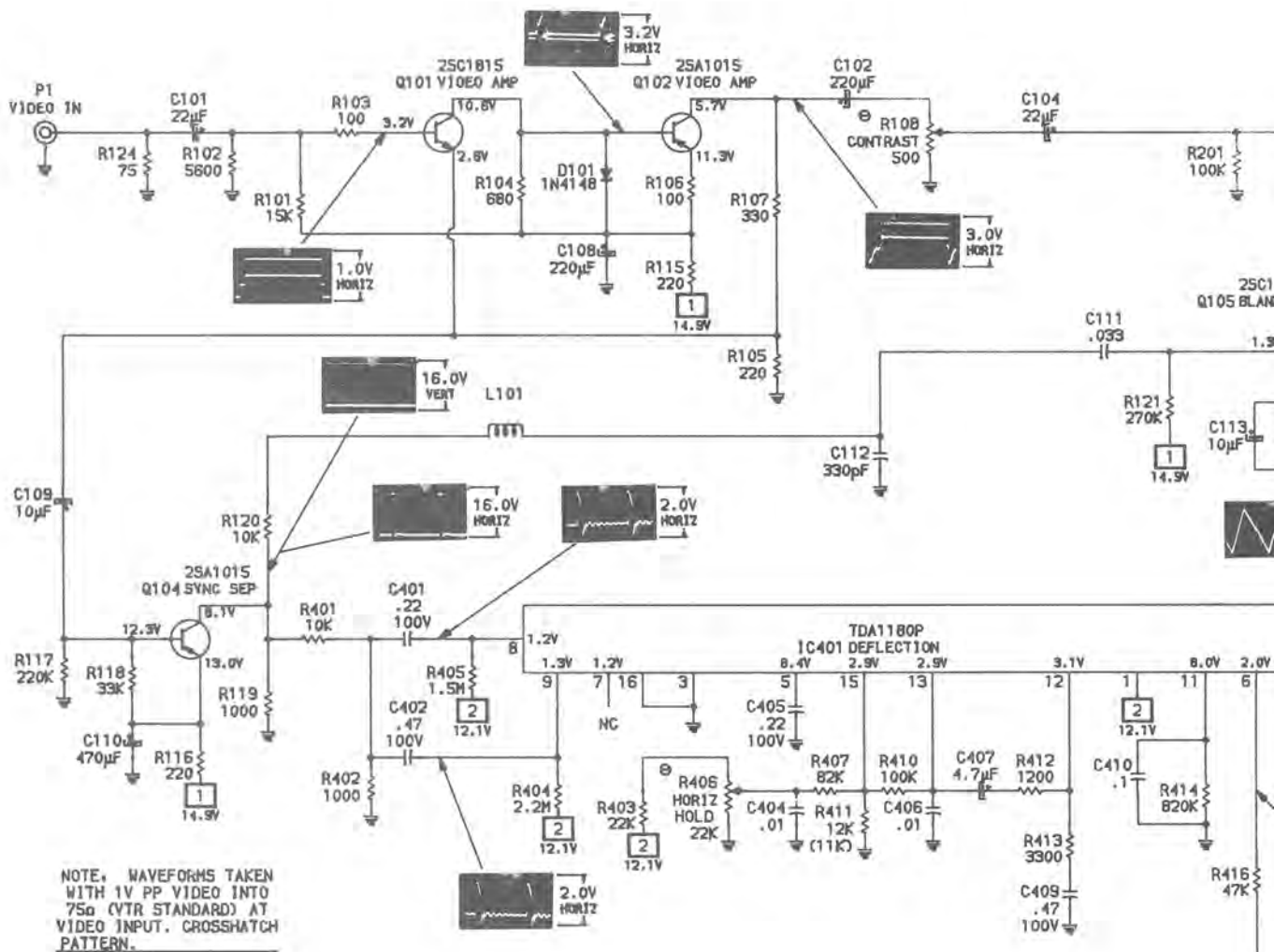

NOTE. WAVEFORMS TAKEN WITH 1V PP VIDEO INTO 75Ω (VTR STANDARD) AT VIDEO INPUT. CROSSHATCH PATTERN.

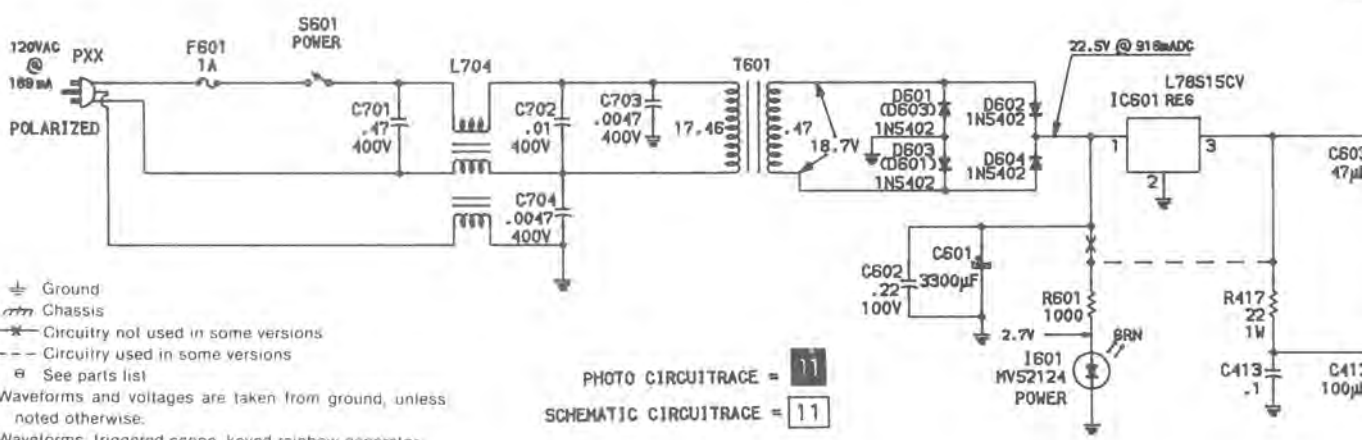

- ⊕ Ground
- Chassis
- Circuitry not used in some versions
- Circuitry used in some versions
- ⊕ See parts list

Waveforms and voltages are taken from ground, unless noted otherwise.
 Waveforms: Triggered scope, keyed rainbow generator.
 Item numbers in rectangles appear in the alignment/adjustment instructions.
 Supply voltages maintained as shown at input.
 Voltages measured with digital meter, no signal.
 Controls adjusted for normal operation.
 Terminal identification may not be found on unit.
 Capacitors are 50 volts or less, 5% unless noted.
 Electrolytic capacitors are 50 volts or less, 20% unless noted.
 Resistors are 1/2W or less, 5% unless noted.
 Value in () used in some versions.

PHOTO CIRCUITRACE = 11
 SCHEMATIC CIRCUITRACE = 11

SEE PINOUTS AND TERMINAL GUIDES ON PAGE 28

A PHOTOFACIT STANDARD NOTATION SCHEMATIC WITH **CIRCUITRACE™**

© Howard W. Sams & Co., Inc. 1986

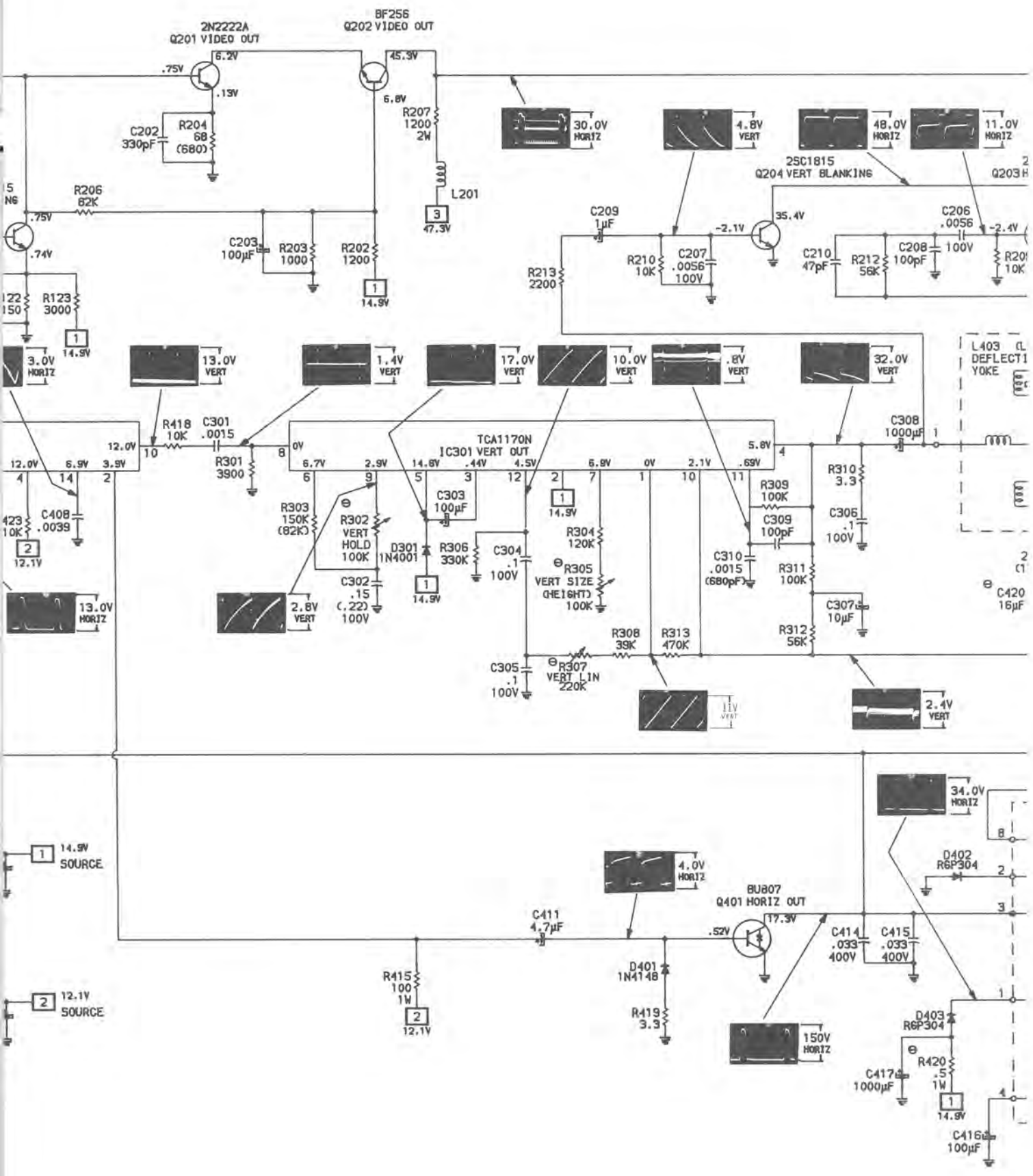

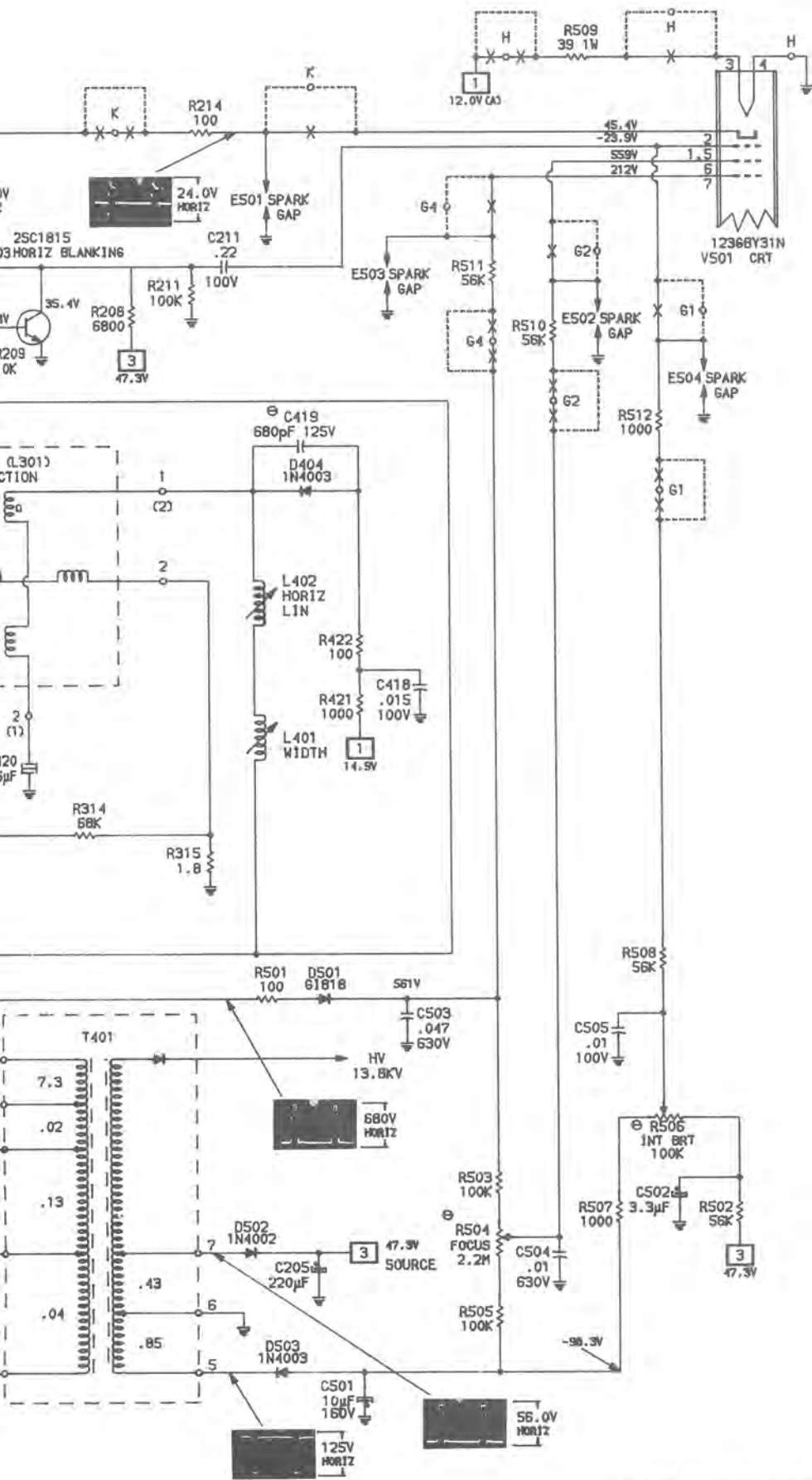

APPLE MONITOR II
MODEL A2M2010

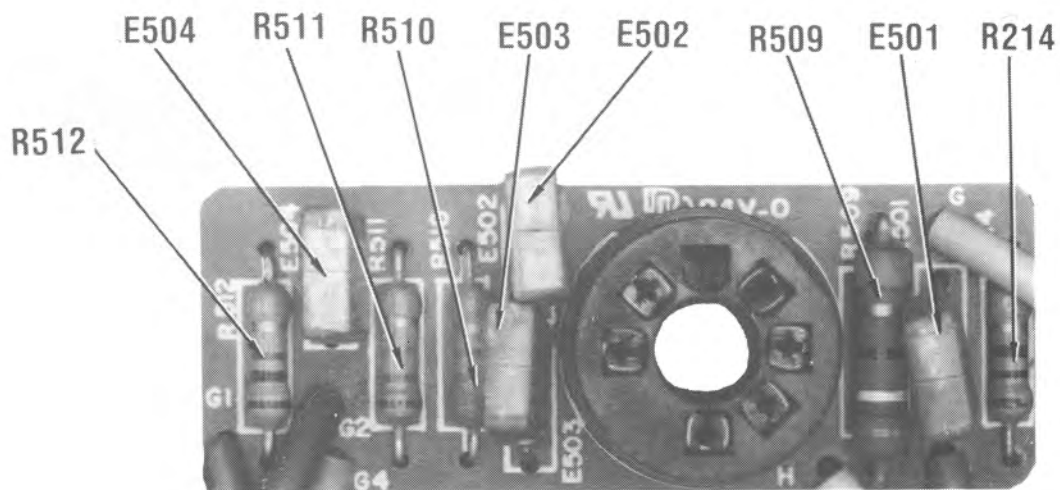

CRT BOARD

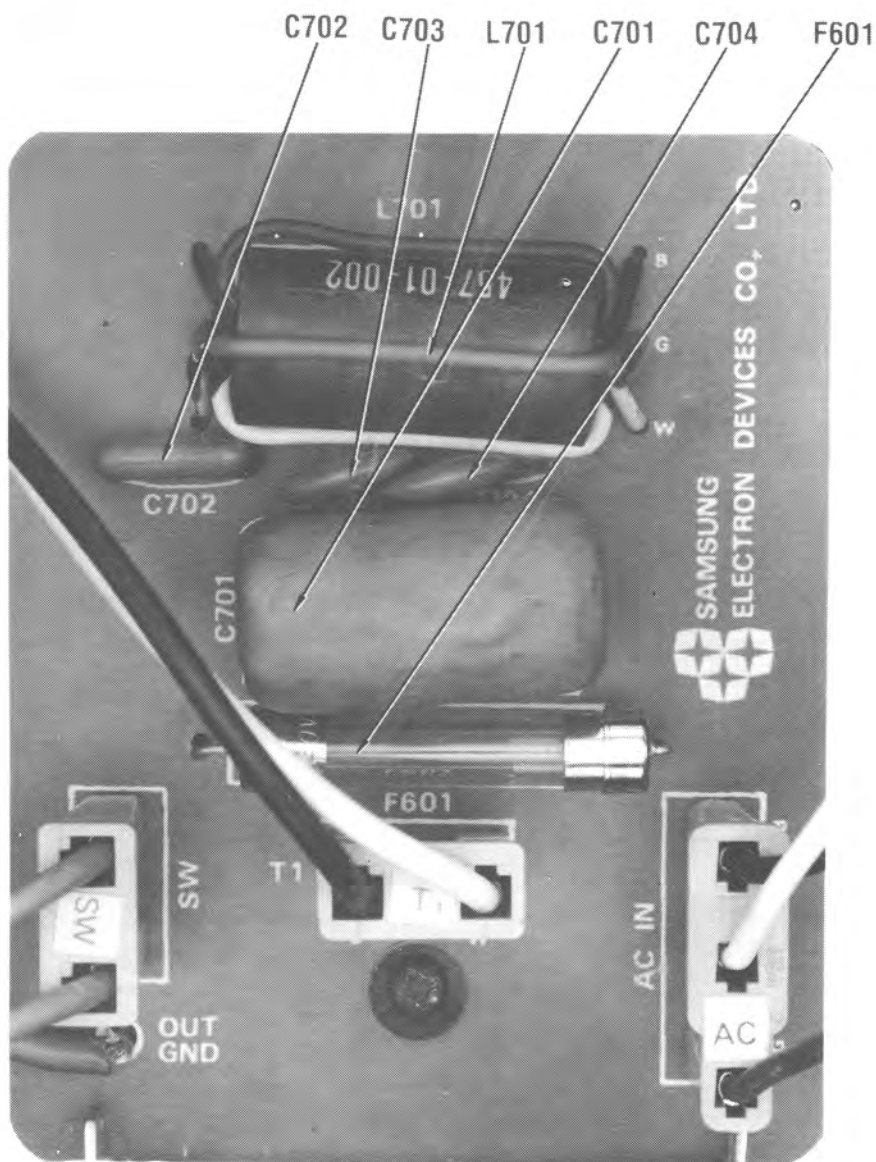

AC INPUT BOARD

CMT9-1

APPLE MONITOR II
MODEL A2M2010

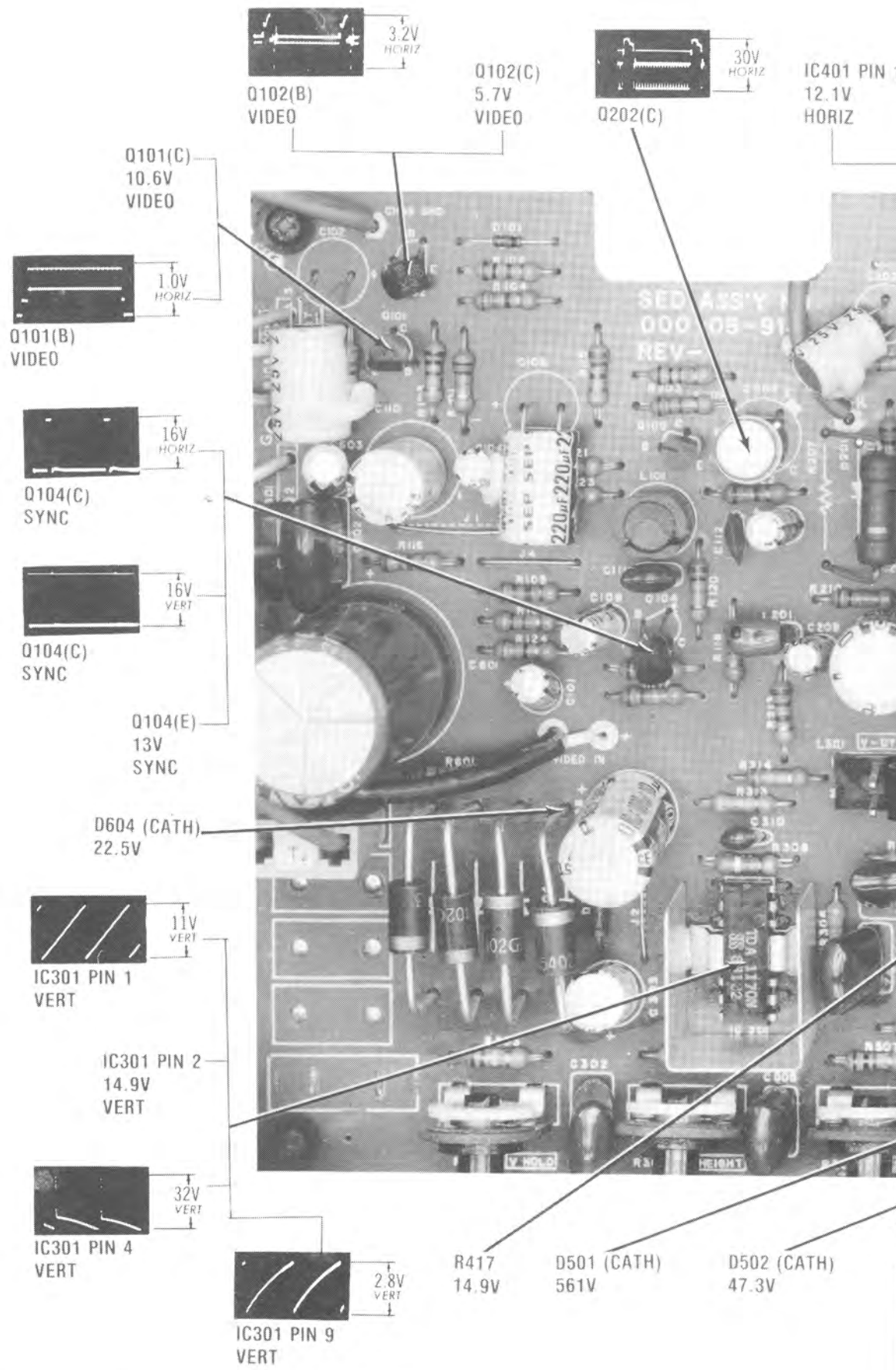

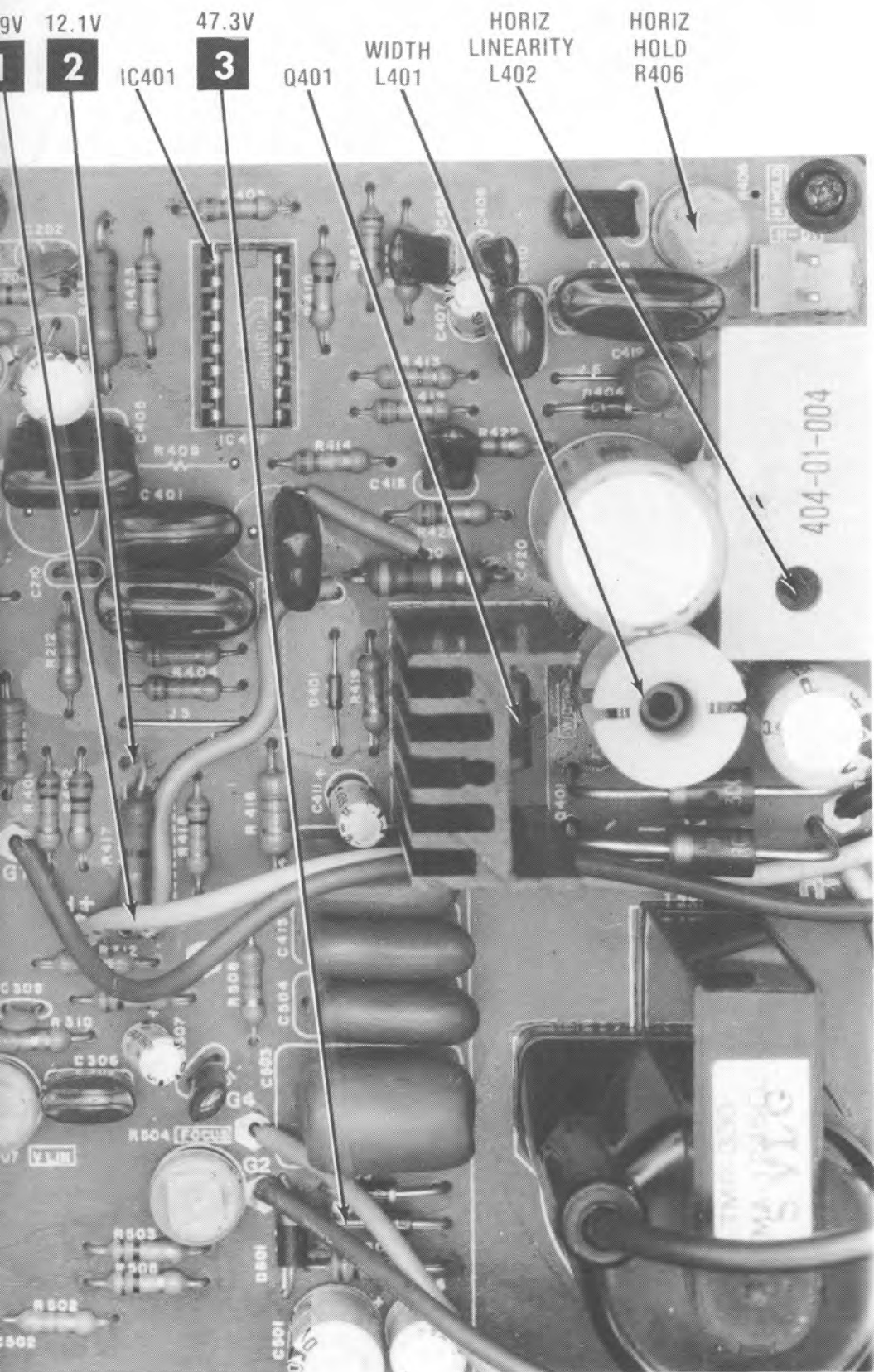

CMT9-1

**APPLE MONITOR II
MODEL A2M2010**

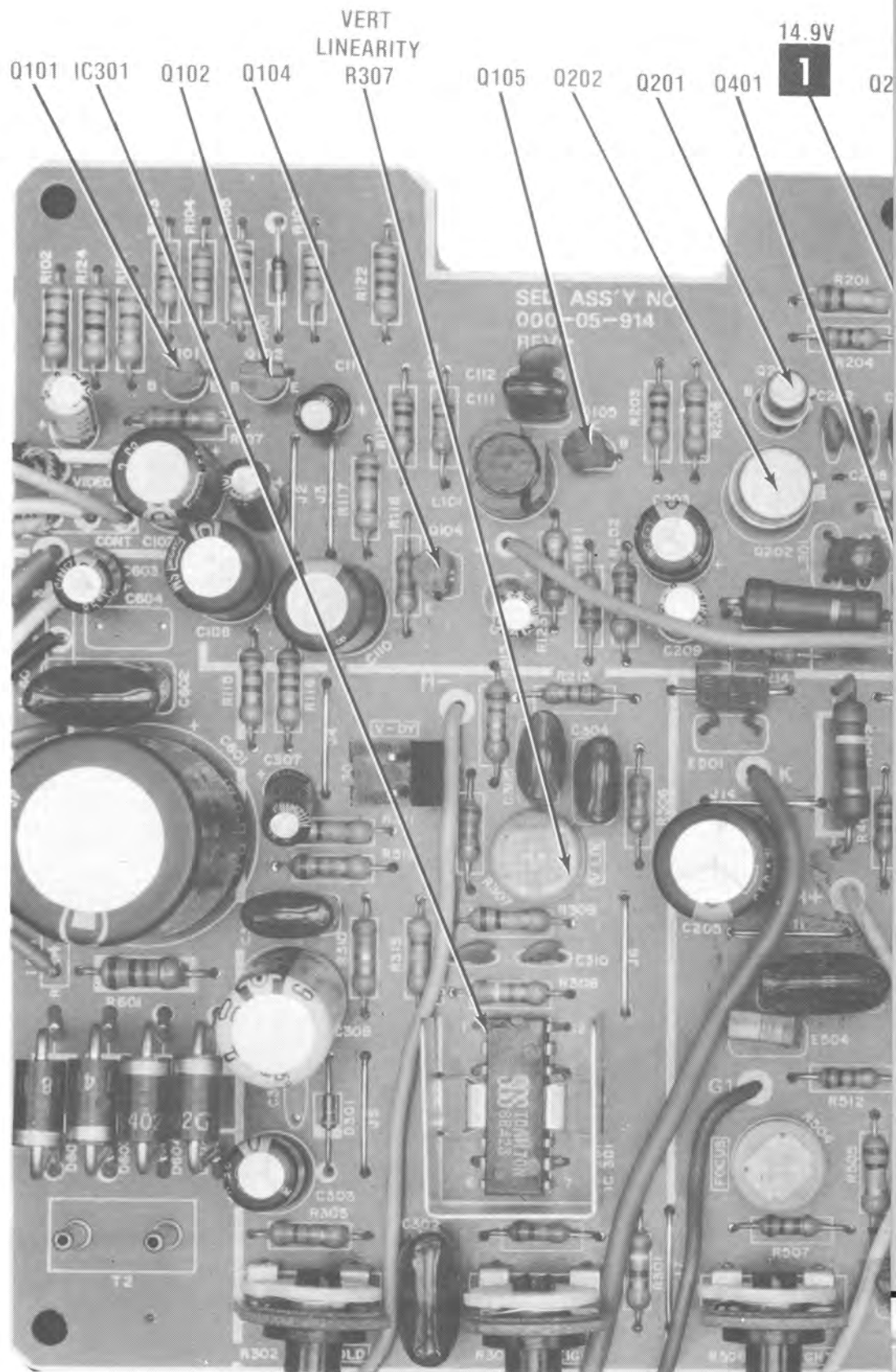

NOTE: ARROWS ON IC'S INDICATE PIN 1 UNLESS NOTED

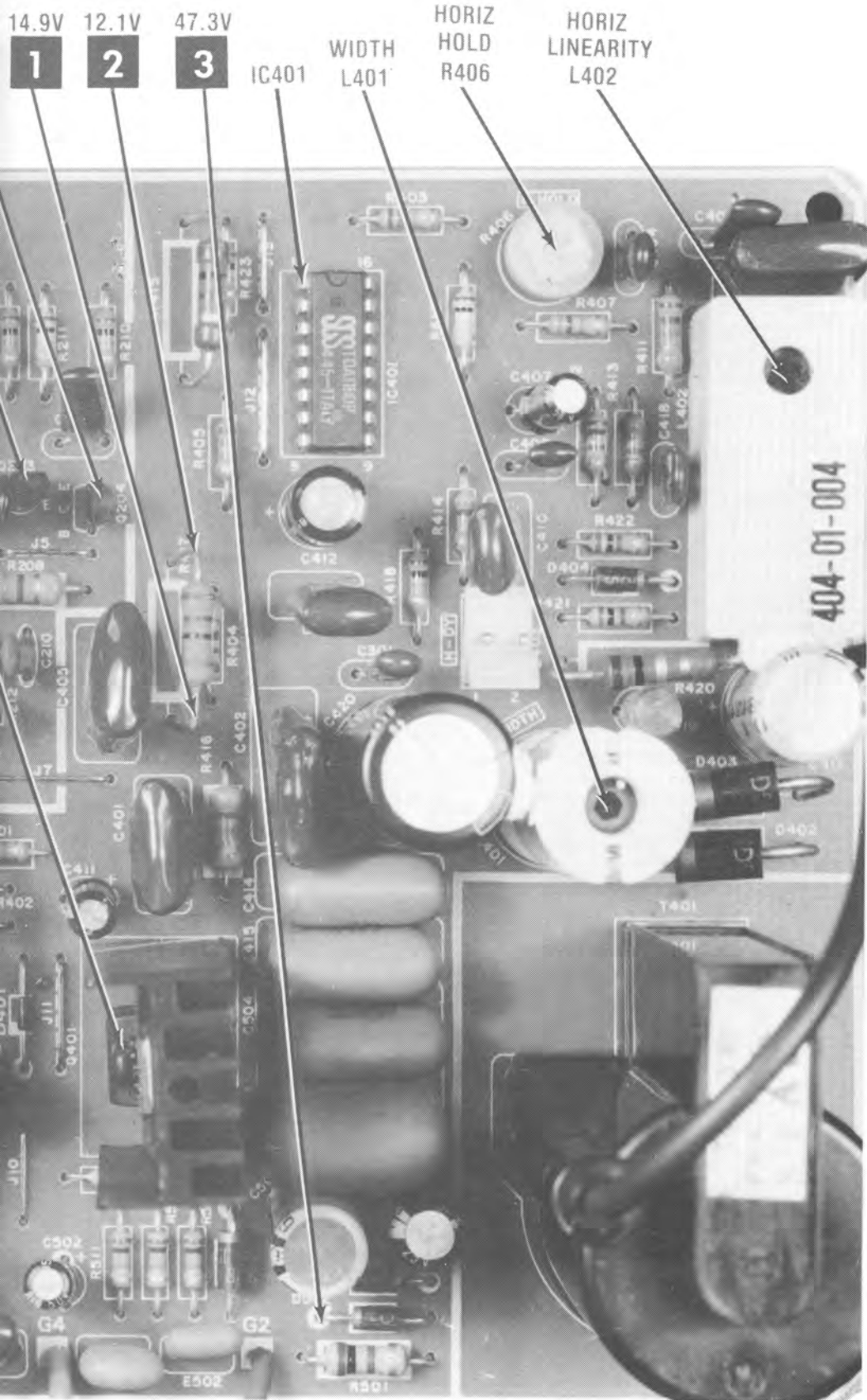

CMT9-1

**APPLE MONITOR II
MODEL A2M2010**

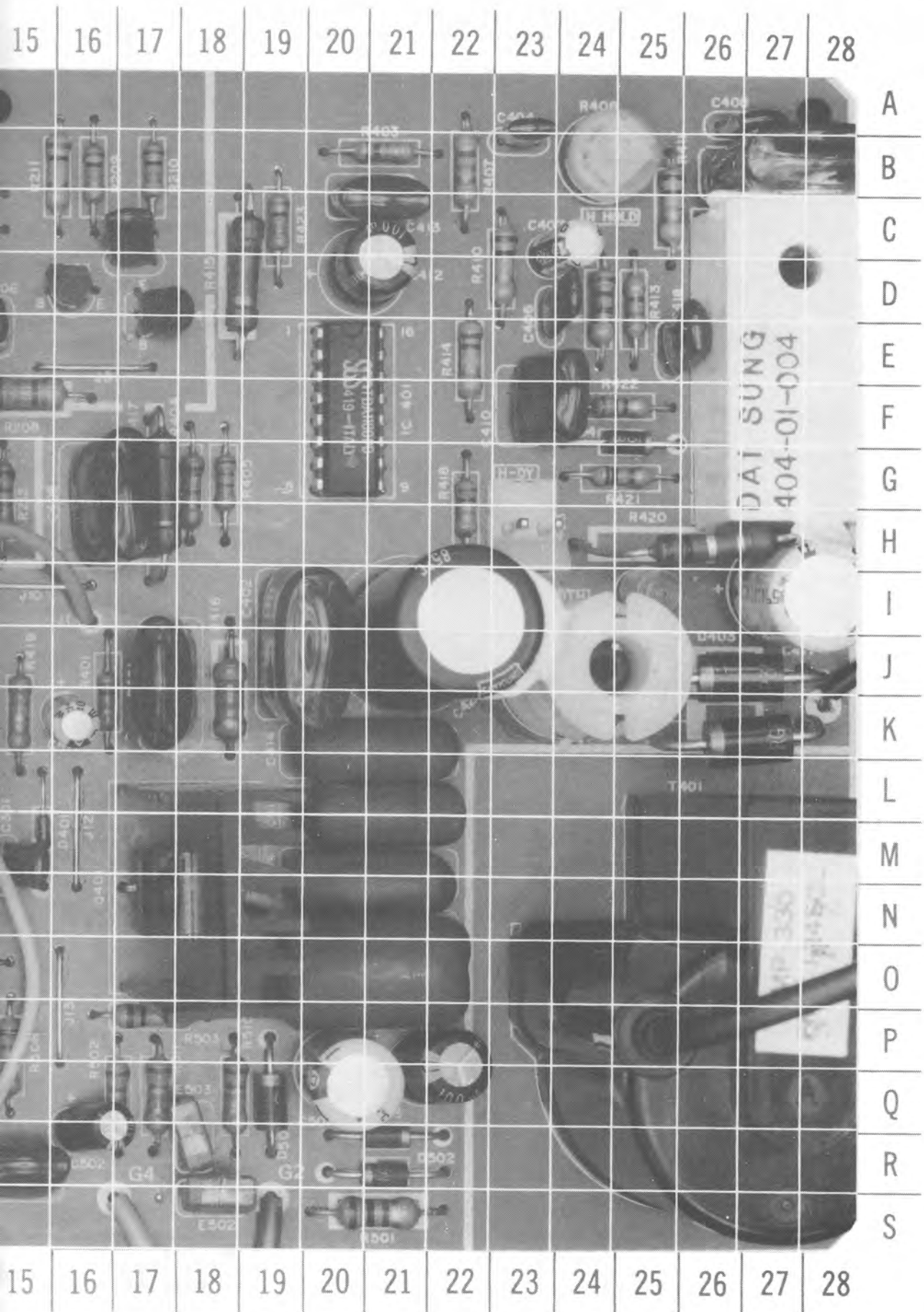

CMT9-1

APPLE MONITOR II
MODEL A2M2010

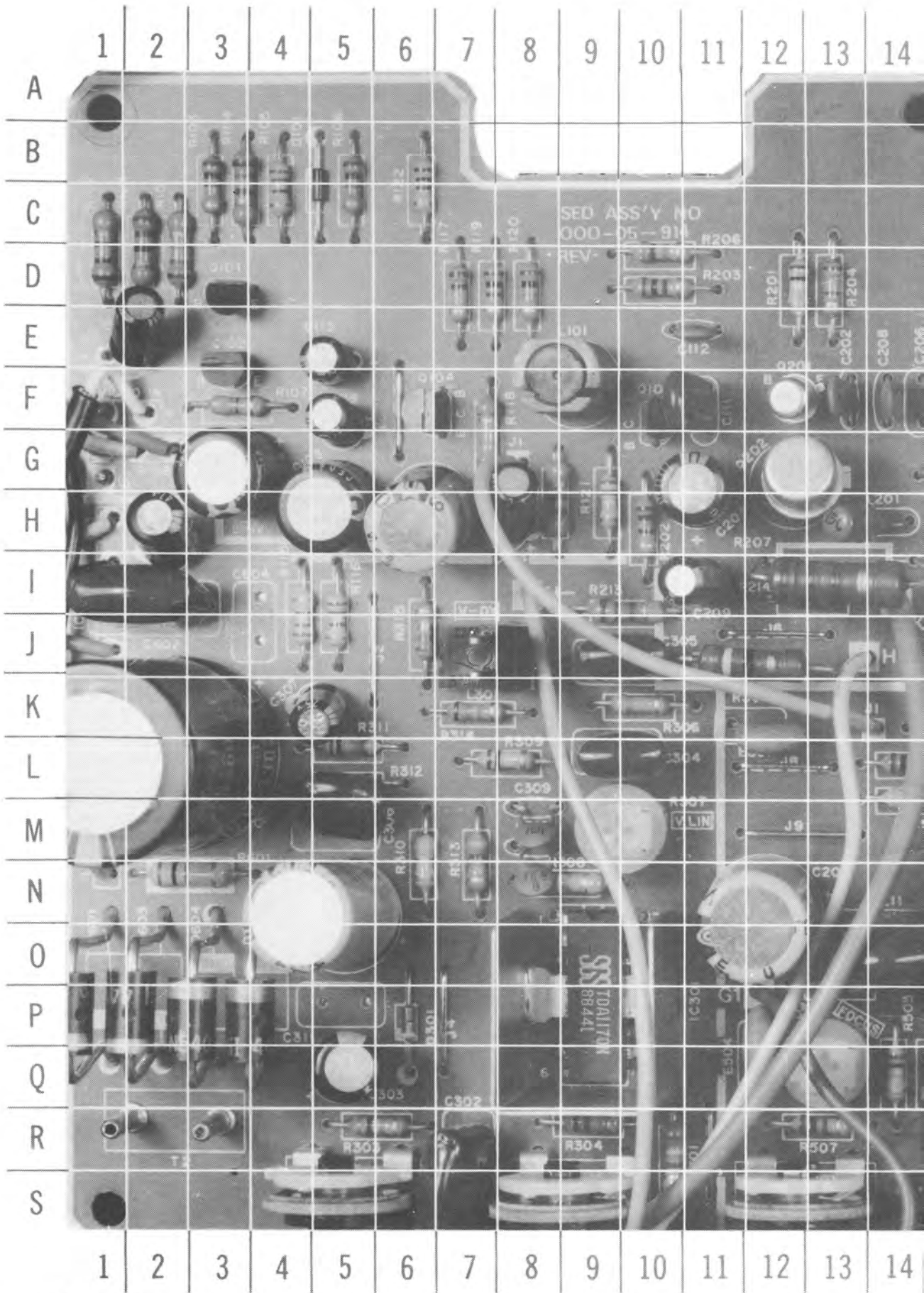

A Howard W. Sams **GRIDTRACE™** Photo **MAIN BOARD 060-01-001 REV C**

BOARD 060-01-001 GridTrace LOCATION GUIDE

C101	J-6	L401	I-25	R423	C-17
C102	D-2	L402	F-27	R501	R-20
C104	F-5	Q101	D-3	R502	S-15
C108	F-6	Q102	B-3	R503	R-17
C109	I-7	Q105	F-9	R504	Q-18
C110	F-3	Q201	D-14	R505	R-17
C111	H-8	Q202	F-10	R506	S-12
C112	G-10	Q203	G-13	R507	Q-12
C113	G-10	Q204	G-14	R508	M-18
C202	B-15	Q401	J-23	R601	L-4
C203	D-12	R101	D-5	T401	P-26
C205	J-12	R102	I-6		
C206	E-14	R103	D-4		
C207	H-13	R104	C-5		
C208	E-14	R105	H-6		
C209	J-11	R106	B-5		
C210	G-16	R107	D-2		
C211	J-14	R115	D-7		
C301	O-18	R116	H-4		
C302	S-7	R117	J-8		
C303	P-7	R118	J-10		
C304	N-13	R119	J-8		
C305	P-12	R120	H-9		
C306	O-16	R121	F-7		
C307	O-17	R122	F-10		
C308	N-17	R123	F-7		
C309	N-15	R124	I-6		
C310	M-10	R201	C-14		
C311	N-17	R202	E-9		
C401	F-17	R203	D-9		
C402	G-17	R204	C-15		
C404	A-24	R205	J-15		
C405	E-16	R206	D-13		
C406	B-22	R207	G-12		
C407	C-22	R209	G-14		
C408	B-21	R210	H-12		
C409	C-25	R211	E-13		
C410	C-23	R212	H-16		
C411	K-20	R213	K-11		
C412	D-16	R301	Q-13		
C413	G-19	R302	S-5		
C414	L-20	R303	Q-5		
C415	M-20	R304	Q-8		
C416	S-21	R305	S-9		
C417	J-27	R306	O-12		
C418	E-22	R307	O-14		
C419	D-25	R308	N-10		
C420	G-25	R309	M-13		
C501	S-20	R310	N-15		
C502	S-14	R312	M-16		
C503	P-21	R313	L-10		
C504	N-21	R314	L-10		
C505	S-10	R315	L-13		
C601	K-2	R401	K-15		
C602	G-2	R402	K-16		
C603	F-2	R403	A-18		
D101	B-5	R404	I-18		
D301	O-7	R405	H-17		
D401	I-20	R406	B-26		
D402	K-26	R407	B-21		
D403	K-26	R410	C-20		
D404	D-24	R411	B-20		
D501	R-19	R412	D-21		
D502	Q-21	R413	D-21		
D503	Q-20	R414	E-20		
D601	O-3	R415	C-16		
D602	O-5	R416	K-19		
D603	O-4	R417	K-17		
D604	O-6	R418	K-18		
IC301	O-10	R419	J-20		
IC401	C-19	R420	G-21		
L101	G-8	R421	F-22		
L201	I-10	R422	E-22		

CMT9-1

**APPLE MONITOR II
MODEL A2M2010**

BOARD 060-01-001 REV B GridTrace LOCATION GUIDE

C101	D-1	L201	G-14	R421	G-25
C102	E-3	L401	J-25	R422	F-25
C104	H-9	Q101	D-3	R423	C-19
C108	G-4	Q102	D-4	R501	S-21
C109	F-4	Q104	G-7	R502	Q-17
C110	H-5	Q105	E-10	R503	P-17
C111	D-9	Q201	D-13	R504	P-13
C112	D-9	Q202	F-13	R505	P-14
C113	E-5	Q203	D-16	R507	Q-13
C202	E-14	Q204	D-17	R508	P-15
C205	L-12	Q401	N-17	R509	J-14
C206	E-15	R101	C-2	R510	Q-18
C307	C-17	R102	C-1	R511	Q-17
C308	E-14	R103	B-3	R512	Q-14
C209	G-11	R104	B-4	R601	M-3
C210	G-14	R105	B-4	T401	P-27
C211	N-13	R106	B-5		
C301	M-15	R107	E-3		
C302	S-7	R115	I-4		
C303	Q-5	R116	I-5		
C304	J-10	R117	F-6		
C305	J-9	R118	G-7		
C306	M-5	R119	E-7		
C307	K-5	R120	D-7		
C308	N-5	R121	G-10		
C309	M-8	R122	B-6		
C310	M-9	R123	G-9		
C401	J-17	R124	C-2		
C402	J-20	R201	C-14		
C404	A-23	R202	G-10		
C405	G-17	R203	D-11		
C406	D-24	R204	C-14		
C407	C-24	R206	D-11		
C408	A-27	R207	G-13		
C409	B-27	R208	F-15		
C410	F-23	R209	B-16		
C411	K-16	R210	B-17		
C412	D-21	R211	B-16		
C413	C-21	R212	G-15		
C414	L-21	R213	I-9		
C415	M-21	R214	H-13		
C416	Q-22	R301	R-11		
C417	I-28	R302	S-5		
C418	E-25	R303	R-5		
C419	I-25	R304	Q-9		
C420	I-22	R305	S-9		
C501	Q-20	R306	K-11		
C502	R-16	R307	L-9		
C503	Q-21	R308	N-8		
C504	N-21	R309	M-8		
C505	R-15	R310	M-6		
C601	K-2	R311	K-6		
C602	I-2	R312	L-6		
C603	G-2	R313	M-7		
D101	B-5	R314	K-8		
D301	P-6	R315	I-8		
D401	M-15	R401	K-16		
D402	K-27	R402	K-14		
D403	J-26	R403	B-21		
D404	F-25	R404	G-18		
D501	Q-19	R405	G-18		
D502	R-21	R406	B-24		
D503	R-21	R407	B-22		
D601	P-1	R410	D-23		
D602	P-4	R411	C-25		
D603	P-2	R412	D-24		
D604	P-3	R413	D-25		
E501	I-12	R414	E-22		
E502	S-18	R415	D-19		
E503	R-18	R416	K-18		
E504	N-12	R417	G-17		
IC301	P-9	R418	G-22		
IC401	F-20	R419	K-15		
L101	E-8	R420	H-26		

BOARD 060-01-001 REV C GridTrace LOCATION GUIDE

C101	E-2	L101	F-8	R419	L-14
C102	G-3	L201	H-13	R420	H-25
C104	G-8	L401	K-24	R421	H-25
C108	H-5	L402	E-27	R422	F-25
C109	F-5	Q101	D-3	R501	S-21
C110	H-6	Q102	F-3	R502	R-17
C111	F-11	Q104	F-6	R503	P-17
C112	E-11	Q105	F-10	R504	Q-13
C113	E-5	Q201	F-12	R505	Q-14
C202	F-13	Q202	G-12	R506	S-12
C203	G-11	Q203	F-15	R507	R-13
C205	N-12	Q204	F-17	R508	Q-14
C206	F-15	Q401	O-17	R509	J-12
C207	D-17	R101	C-2	R510	R-18
C208	F-14	R102	C-1	R511	R-17
C209	I-11	R103	C-3	R512	P-13
C210	H-15	R104	C-3	R601	N-3
C211	O-14	R105	C-4	T2	R-3
C301	H-21	R106	C-5	T401	P-27
C302	S-7	R107	F-3		
C303	Q-5	R115	J-4		
C304	L-10	R116	J-5		
C305	J-10	R117	D-7		
C306	M-5	R118	F-7		
C307	K-4	R119	D-7		
C308	N-4	R120	D-8		
C309	M-8	R121	H-9		
C310	N-8	R122	C-6		
C401	K-17	R123	H-8		
C402	K-20	R124	D-2		
C404	B-25	R201	D-12		
C405	H-17	R202	H-10		
C406	E-25	R203	D-10		
C407	D-24	R204	D-13		
C408	B-26	R206	D-10		
C409	B-27	R207	I-13		
C410	G-23	R208	G-15		
C411	L-16	R209	C-15		
C412	F-20	R210	C-17		
C413	H-20	R211	C-16		
C414	L-20	R212	I-15		
C415	M-20	R213	I-10		
C416	Q-22	R214	I-12		
C417	I-28	R301	R-10		
C418	E-25	R302	S-5		
C419	I-25	R303	R-6		
C420	J-22	R304	R-9		
C501	R-20	R305	S-9		
C502	R-16	R306	K-10		
C503	P-20	R307	M-9		
C504	N-20	R308	N-9		
C505	S-14	R309	L-8		
C601	L-1	R310	N-6		
C602	I-2	R311	L-5		
C603	H-2	R312	L-5		
D101	C-5	R313	N-7		
D301	P-6	R314	K-7		
D401	N-15	R315	J-6		
D402	K-26	R401	K-15		
D403	J-26	R402	L-14		
D404	G-25	R403	A-21		
D501	R-19	R404	H-18		
D502	S-21	R405	E-19		
D503	R-21	R406	B-24		
D601	P-1	R407	C-24		
D602	P-3	R410	C-22		
D603	P-2	R411	C-25		
D604	P-3	R412	E-24		
E501	K-12	R413	E-25		
E502	S-18	R414	F-22		
E503	S-17	R415	C-18		
E504	P-12	R416	K-19		
IC301	P-9	R417	H-18		
IC401	D-20	R418	G-21		

CMT9-1

APPLE MONITOR II
MODEL A2M2010

4 PARTS LIST AND DESCRIPTION

When ordering parts, state Model, Part Number, and Description

SEMICONDUCTORS (Select replacement transistor for best results)

ITEM No.	TYPE No.	MFR. PART No.	REPLACEMENT DATA					
			NOTES	NTE PART No.	ECG PART No.	RCA PART No.	WORKMAN PART No.	ZENITH PART No.
D101	1N4148			NTE519	EG519	SK3100/519	WEP925/519	103-131
D301	1S2473	(1) (2)		NTE519	EG519	SK3100/519	WEP925/519	103-131
D401	1N4001	(3)		NTE116	EG116	SK3311	WEP154	212-76-02
D402,3	1N4148			NTE519	EG519	SK3100/519	WEP925/519	103-131
	RGP30G			NTE580	EG580	SK5036/580		103-316-04
D404	1N4003			NTE116	EG116	SK3311	WEP156	212-76-02
D501	G1818			NTE506	EG506	SK3998/506	WEP172/506	103-287
	MR818			NTE506	EG506	SK3998/506	WEP172/506	103-287
	PLR818			NTE506	EG506	SK3998/506	WEP172/506	103-287
D502	1N4002			NTE116	EG116	SK3311	WEP155	212-76-02
D503	1N4003			NTE116	EG116	SK3311	WEP156	212-76-02
D601 thru	1N5402			NTE5802	EG5802	SK9005/5802	WEP4002/5802	212-Z9000
D604	TDA1170N			NTE1289	EG1289	SK9182/1289		
IC301	TDA1180P	(1)(3)						
IC401	TDA1180PD	(2)						
IC601	L78S15CV			NTE968	EG968	SK3593/968		HE-442-63
	7815			NTE968	EG968	SK3593/968		HE-442-63
Q101	2SC945CY	(1)		NTE85	EC85	SK3124A/289A	WEP736/123A*	121-972
	2SC1815BL	(2)		NTE85	EC85	SK3124A/289A	WEP66/199	121-29065
	2SC1815GR	(3)		NTE85	EC85	SK3124A/289A	WEP66/199	121-29065
Q102	2SA1015GR			NTE290A	EG290A	SK9132	WEP911/290A	121-Z9003*
Q104	2SA1015GR			NTE290A	EG290A	SK9132	WEP911/290A	121-Z9003*
Q105	2SC945CY	(1)		NTE85	EC85	SK3124A/289A	WEP736/123A*	121-972
	2SC1815BL	(2)		NTE85	EC85	SK3124A/289A	WEP66/199	121-29065
	2SC1815GR	(3)		NTE85	EC85	SK3124A/289A	WEP66/199	121-29065
Q201	2N2222A			NTE123A	EG123A	SK3444/123A*	WEP736/123A	121-Z9000A
Q202	BF258			NTE396	EG396	SK3103A/396		
Q203,4	2SC945CY	(1)		NTE85	EC85	SK3124A/289A	WEP736/123A*	121-972
	2SC1815BL	(2)		NTE85	EC85	SK3124A/289A	WEP66/199	121-29065
	2SC1815GR	(3)		NTE85	EC85	SK3124A/289A	WEP66/199	121-29065
Q401	BU807				EG2315			

(1) Board 060-01-001 Revision C.

(2) Board 060-01-001 Revision B.

(3) Board 060-01-001.

* Lead configuration may vary from original.

PARTS LIST AND DESCRIPTION (Continued)

When ordering parts, state Model, Part Number, and Description

ELECTROLYTIC CAPACITORS Items Not Listed Are Normally Available At Local Distributors.

ITEM No.	RATING	MFGR. PART No.
C420	16 25V NP	

CAPACITORS

ITEM No.	RATING	MFGR. PART No.
C419	680 120V AC	

RESISTORS (Power and Special)

ITEM No.	RATING	REPLACEMENT DATA		
		MFGR. PART No.	NTE PART No.	WORKMAN PART No.
R420	.5 5% 1W Metal Oxide			

(1) Used as fuse.

COILS (RF-IF)

ITEM No.	FUNCTION	MFGR. PART No.
L101	RF Choke (15mH)	
L201	RF Choke (15uH)	

COILS & TRANSFORMERS

ITEM No.	FUNCTION	MFGR. PART No.	OTHER IDENTIFICATION	NOTES
L401	Width		403-01-004 (1)	
L402	Horiz Linearity		404-01-004 (1)	
L403	Yoke Horiz 99.7uH 90° Vert 14.2mH		DMB-1294BL (1)	
T401	Horiz Output		FMA-1245CL/ TMP-330 (1)	
T601	Power		APT001U (1)	
L704	AC Line Filter			

(1) Number on unit.

CONTROLS (All wattages 1/2 watt, or less, unless listed)

ITEM NO.	FUNCTION	RESISTANCE	MFGR. PART NO.	NOTES
R108	Contrast	500		
R302	Vert Hold	100K		
R305	Vert (Height) Size	100K		
R307	Vert Linearity	200K		
R406	Horiz Hold	22K		
R504	Focus	2.2M		
R506	INT BRT	100K		

APPLE MONITOR II
MODEL A2M2010

PARTS LIST AND DESCRIPTION (Continued)

When ordering parts, state Model, Part Number, and Description

FUSE DEVICES

ITEM NO.	DESCRIPTION	MFR. PART NO.		NOTES
		DEVICE	HOLDER	
F601	1A @ 250V Fast Acting Pigtail 500mA @ 110V Fast Acting 500mA @ 230V Slow Blow 200mA @ 230V			

MISCELLANEOUS

ITEM No.	PART NAME	MFR. PART No.	NOTES
E501 Thru E504	Spark Gap		
I601	LED		Power, Green
P1	Jack		Video Input
S601	Switch		Power, 115V
V501	CRT		Power, 230V
	Foot		
	Magnet		Square, White
	Magnet		Square, Red
	Magnet		Square, Green
	Magnet		Square, Blue
	Magnet		Square, Yellow
	Power Cord		
	PC Board		Main

CABINETS & CABINET PARTS (When ordering specify model, chassis & color)

WIRING DATA

High Voltage Lead	Use BELDEN No. 8869 (17 KV)
Shielded Hook-up Wire	Use BELDEN No. 8401 or 8421 (Single-Conductor) 8208 (Two-Conductor)
General-use Unshielded Hook-up Wire	Use BELDEN No. 8529 (Solid) Available in 13 Colors 8522 (Stranded) Available in 13 Colors
Power Cord	Use BELDEN No. 8895 (Polarized Interlocking Type)

TEST EQUIPMENT

Test Equipment listed by Manufacturer illustrates typical or equivalent equipment used by SAMS³ Engineers to obtain measurements and is compatible with most types used by field service technicians.

TEST EQUIPMENT (COMPUTERFACTS)

Equipment Name	B & K Precision Equipment No.	Sencore Equipment No.	Simpson Equipment No.
OSCILLOSCOPE	1570A,1590A,1596	SC61	454
LOGIC PROBE	DP51		
LOGIC PULSER	DP101		
DIGITAL VOM	2830	DVM37,DVM56,SC61	463,467,470,474,467E
ANALOG VOM	277		260-7,160,165, 260-6XL,260-7P, 260-6XLP
ISOLATION TRANSFORMER	TR110,1604,1653,1655	PR57	
FREQUENCY COUNTER	1803,1805	FC71,SC61	710
COLOR BAR GENERATOR	1211A,1248,1251,1260	CG25,VA62	431
RGB GENERATOR	1260		
FUNCTION GENERATOR	3020		420A,420D
HI-VOLTAGE PROBE VOM/DMM Accessory probes	HV-44	HP200	248 00168,00411,00749
TEMPERATURE PROBE	TP-28		IR-10,00760,00758; 383,389,388
CRT ANALYZER	467,470	CR70	

TROUBLESHOOTING

POWER SUPPLY

Check AC Fuse F601, if open, check Capacitors C701 thru C704, Transformer T601, Bridge Rectifier Diodes D601 thru D604 and Regulator IC (IC601). If Fuse F601 is good apply 120V AC and check for 22.5V at the cathode of Diode D604. If this voltage is absent, check the Power Switch S601 and the AC Line Filter. If 22.5V is present at the cathode of Diode D604, check for 14.9V at pin 3 of IC601. If this voltage is absent, check the voltages and components associated with IC601 and check the Horizontal Output Transistor (Q401). If 14.9V is present at pin 3 of IC601, refer to the "Horizontal" section of this Troubleshooting guide.

HORIZONTAL

Check for 14.9V at the collector of the Horizontal Output Transistor (Q401). If this voltage is absent, check Resistor R420, Diode D403, and refer to the "Power Supply" section of this Troubleshooting guide. If 14.9V is present at the collector of Q401, inject a horizontal signal at the base of Transistor Q401. If horizontal deflection is now present, check the voltages, waveforms and components associated with pins 1, 2, 4, 5, 6, 11, 12, 13 and 14 and 15 of Deflection IC (IC401). If there is still no horizontal sweep, check the voltages, waveforms and components associated with the Horizontal Output Transformer (T401). The High Voltage Rectifier is part of Transformer T401 and if defective will affect the operation of the horizontal circuits. If the horizontal oscillator is off frequency, check the voltages, waveforms and components associated with pins 13, 14 and 15 of IC401. Horizontal linearity or foldover problems may be caused by defective Capacitors C414, C415, C420 or Coils L401 and L402.

VIDEO

Inject a video signal at the Video Input Jack (P1) and check for video on the CRT. If there is no video, check the voltages, waveforms and components associated with Video Amp Transistors Q101, Q102, Q201, Q202, and check the CRT and CRT voltages. Check blanking Transistors Q203, Q204 and associated components. If there is inadequate Brightness or Contrast, check the voltages and components associated with Contrast and Brightness Controls (R108 and R506) and check the voltage on pins 1 and 5 of the CRT.

VERTICAL

Check the voltages on Vertical Output IC (IC301). If these voltages are absent, check IC301 and refer to the "Power Supply" section of this Troubleshooting guide. If the proper voltages are present on IC301, check for a Vertical waveform at pin 4 of IC301. If this waveform is absent, check the components associated with IC301. If a vertical waveform is present at pin 4, check Electrolytic C308 and the Deflection Yoke (L430). Check Electrolytics C209, C303, C307 for defects.

SYNC

If there is no Vertical or Horizontal Sync, check for a video waveform at the collector of Sync Separator Transistor (Q104). If this waveform is absent, check Transistor Q104 and associated components. If there is no Vertical Sync, check the voltages, waveforms and components associated with pins 8, 9 and 10 of Deflection IC (IC401). If there is no Horizontal Sync, check the voltages, waveforms and components associated with pins 8, 9, 13 and 15 of IC401.

MISCELLANEOUS ADJUSTMENTS

HORIZONTAL WIDTH ADJUSTMENT

Connect a pattern generator (1VPP into 75Ω VTR Standard) to the video input and tune in a crosshatch pattern. Adjust L401 to obtain a pattern that is equal on each side and not squeezed together.

HORIZONTAL LINEARITY

Connect a pattern generator (1VPP into 75Ω VTR Standard) to the video input and tune in a crosshatch pattern. If L402 is not factory sealed, adjust to obtain proper linearity.

Note: Alternate Width and Linearity adjustments until pattern is correct.

HORIZONTAL HOLD

Connect a pattern generator (1VPP into 75Ω VTR Standard) to the video input and select a crosshatch pattern. Adjust Horizontal Hold Control (R406) until pattern locks in position. This adjustment will also eliminate tearing.

VERTICAL LINEARITY

Connect a pattern generator (1VPP into 75Ω VTR Standard) to the video input and select a crosshatch pattern. Adjust Vertical Linearity Control (R307) to make pattern even at top and bottom.

Note: Vertical Height Control can affect linearity.

PINCUSHION ADJUSTMENT

To correct Pincushion effect on the C.R.T. Raster place a magnet on the yoke mounting pin that corresponds with the affected area. Top Bow is corrected with a magnet at 0° (top center) pin. Left side Bow is corrected with a magnet at 90° clockwise pin. Bottom Low is corrected with a magnet at 180° clockwise pin. Right side Bow is corrected with a magnet at 270° clockwise pin. Rotate magnets on pin to obtain desired raster.

Note: If a second magnet is needed on any one pin the poles of the magnets must be aligned and both magnets rotated simultaneously.

TRAPEZOIDAL ADJUSTMENT

To correct a trapezoidal effect on the C.R.T. raster place a magnet on the yoke mounting pin that corresponds to the affected area. Place a magnet on the pin 45° clockwise from top center to correct top left corner. Place a magnet on the pin 135° clockwise from top center to correct bottom left corner. Place a magnet on the pin 225° clockwise from top center to correct bottom right corner. Place a magnet on the pin 315° clockwise from top center to correct top right corner. Rotate magnets to obtain desired raster.

Note: If a second magnet is needed on any one pin the poles of the magnet must be aligned and both magnets rotated simultaneously.

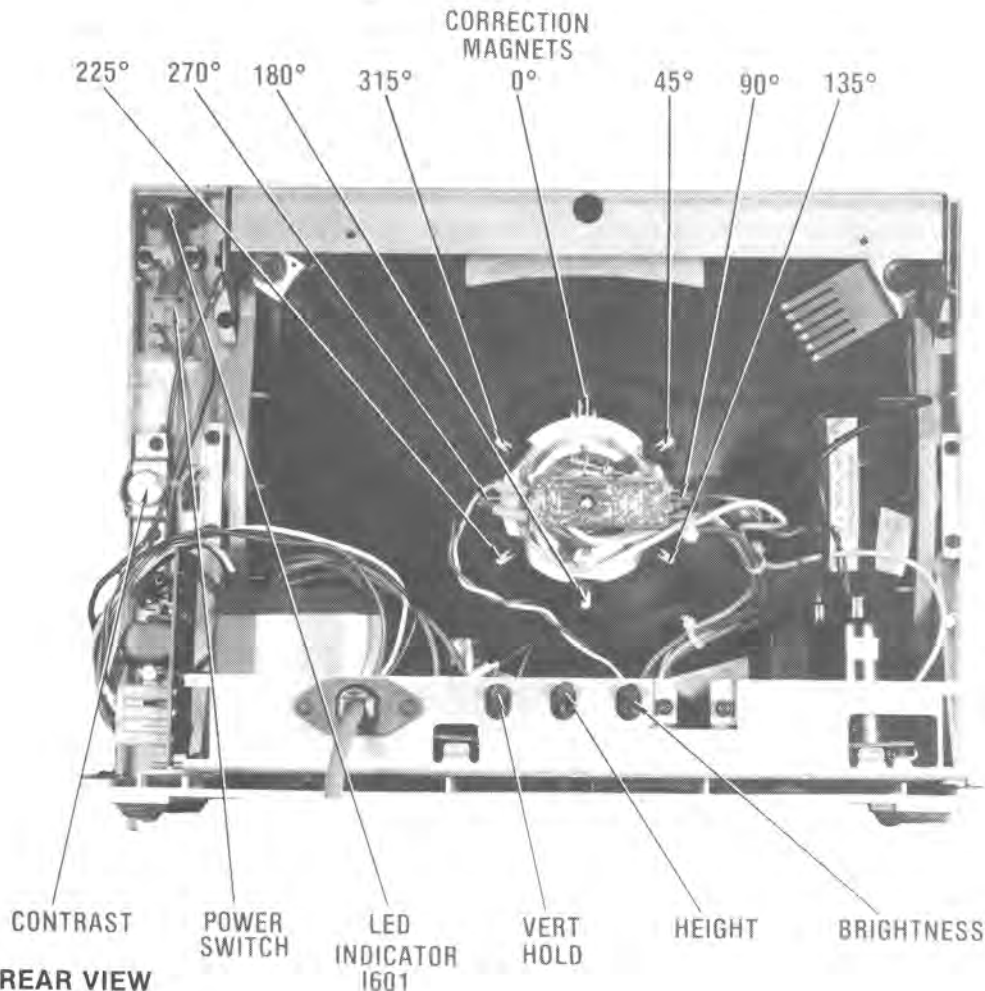

CABINET-REAR VIEW

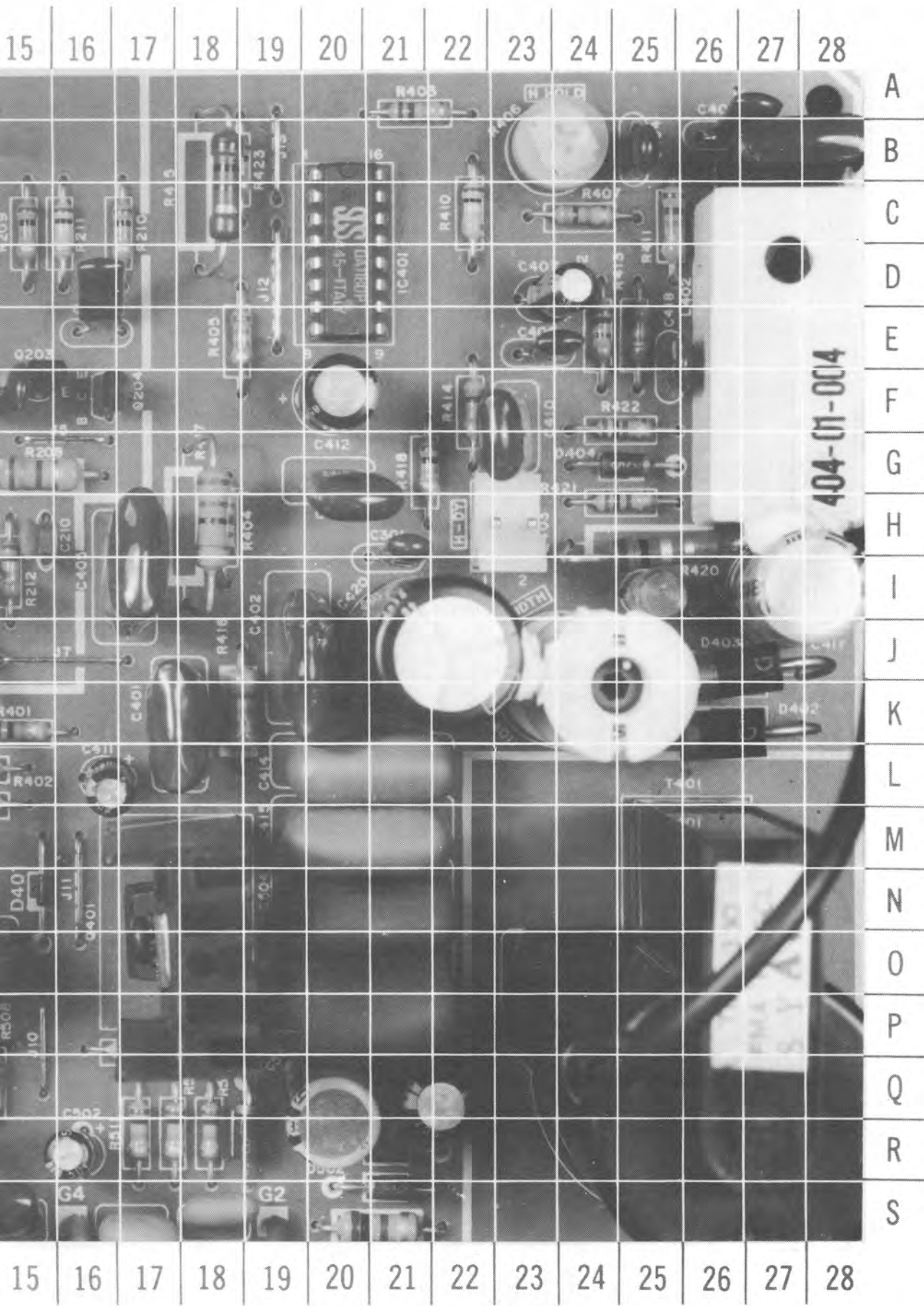

APPLE MONITOR II
MODEL A2M2010

MAIN BOARD 060-01-001 REV C

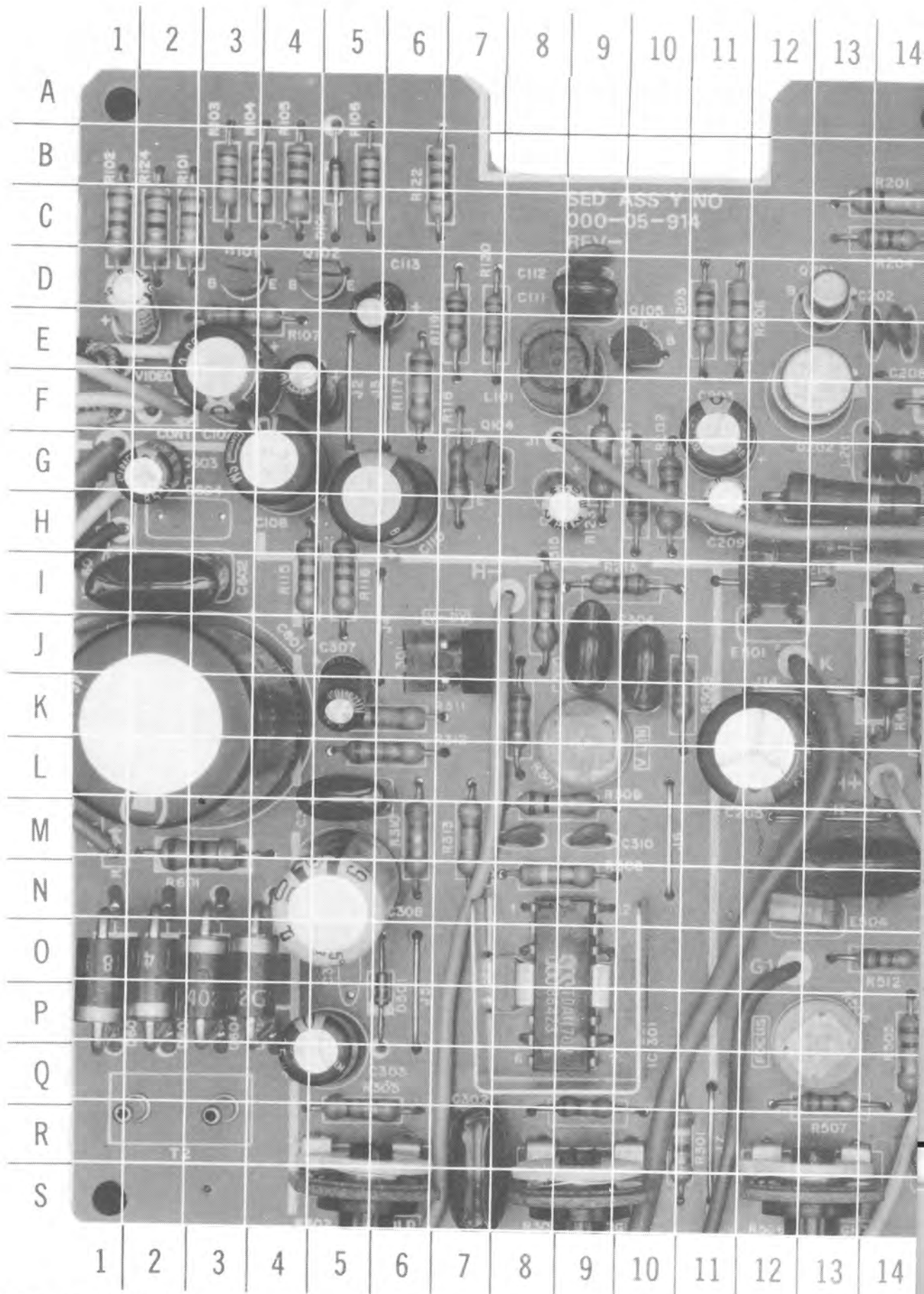

MAIN BOARD 060-01-001 REV B



APPLE MONITOR II
MODEL A2M2010

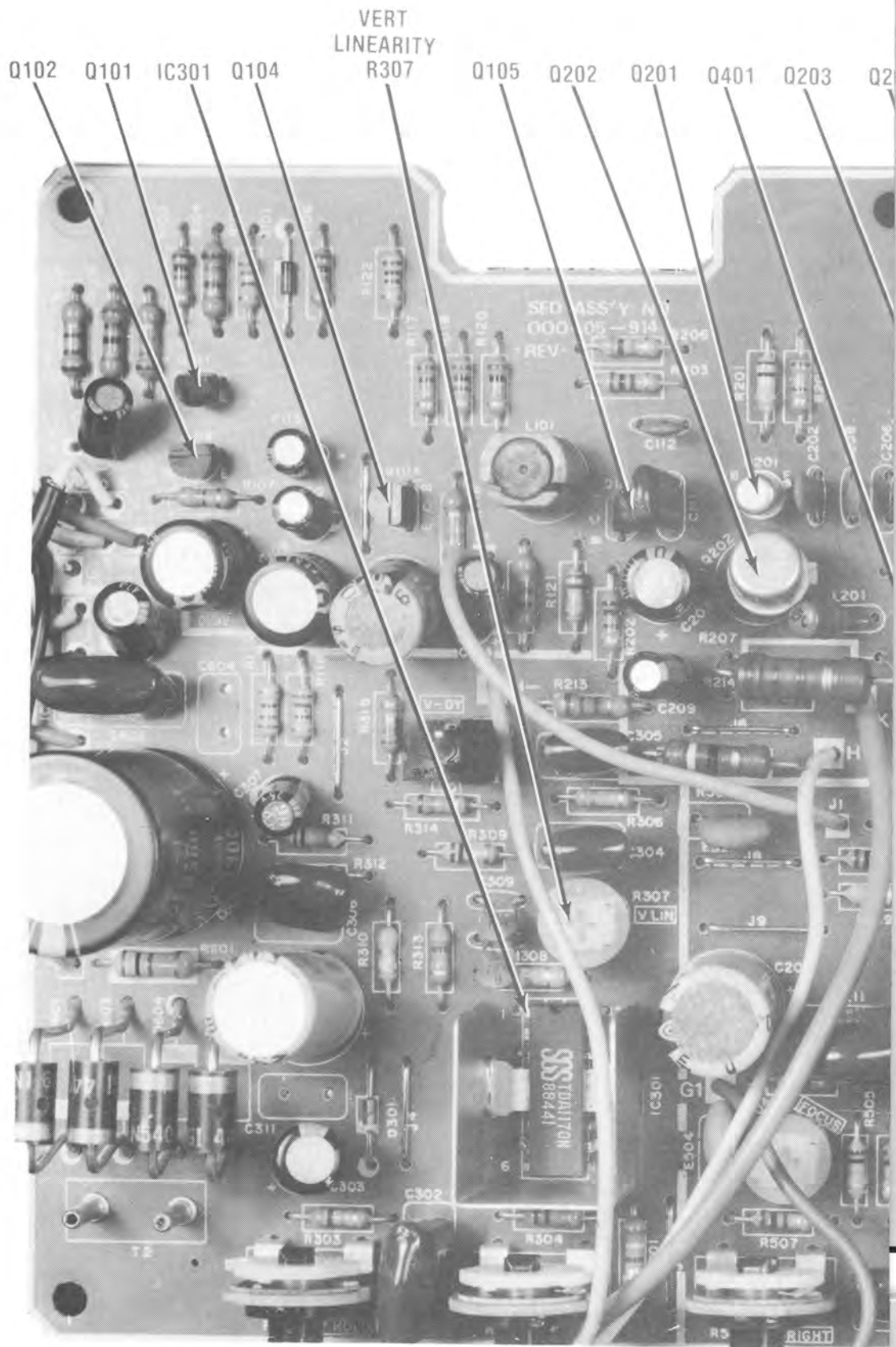

NOTE: ARROWS ON IC'S INDICATE PIN 1 UNLESS NOTED

MAIN BOARD 060-01-001 REV C

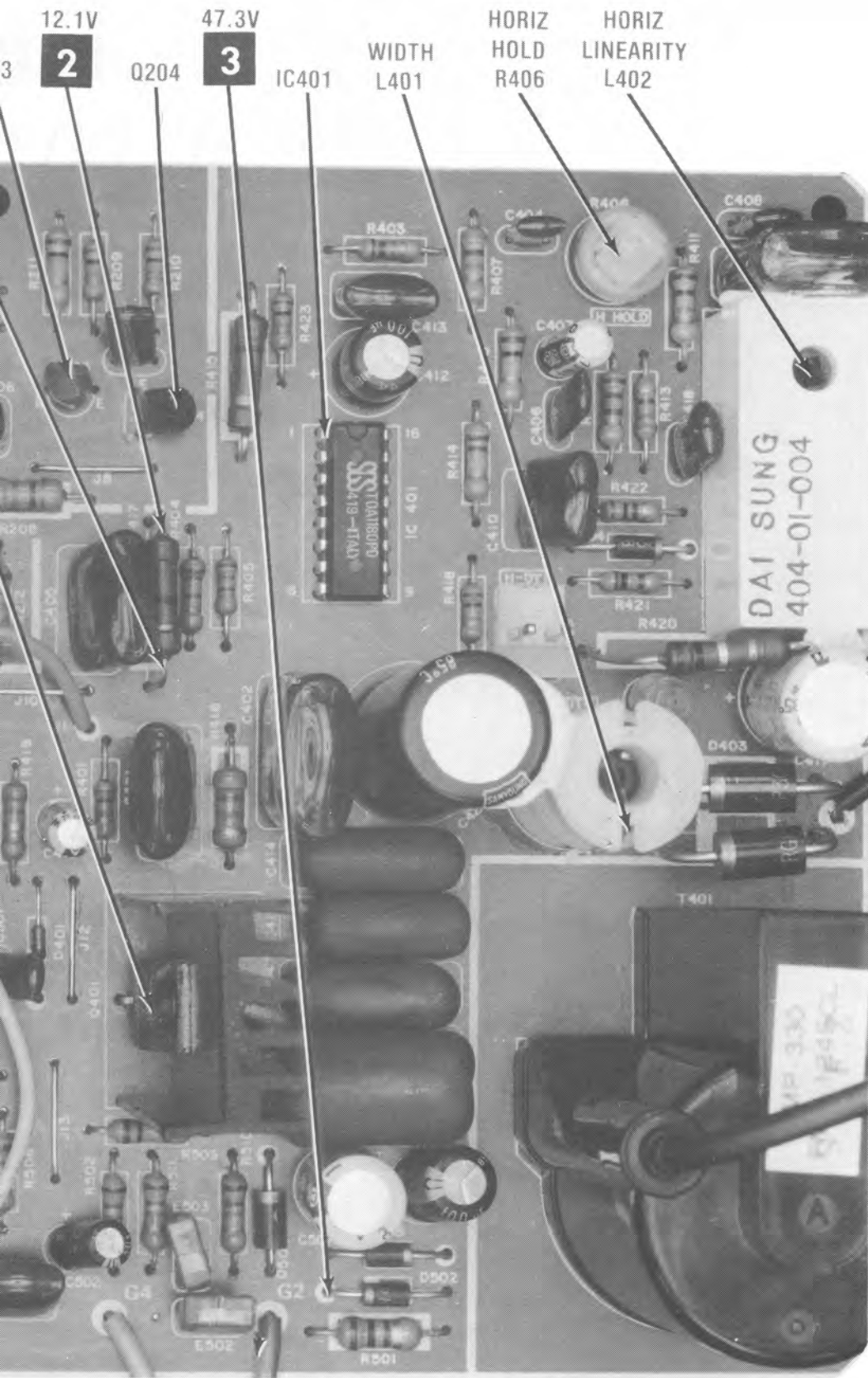

APPLE MONITOR II
MODEL A2M2010

Q101 Q102 IC301 Q104 Q105 Q202 VERT LINEARITY R307 Q203 Q204 Q201

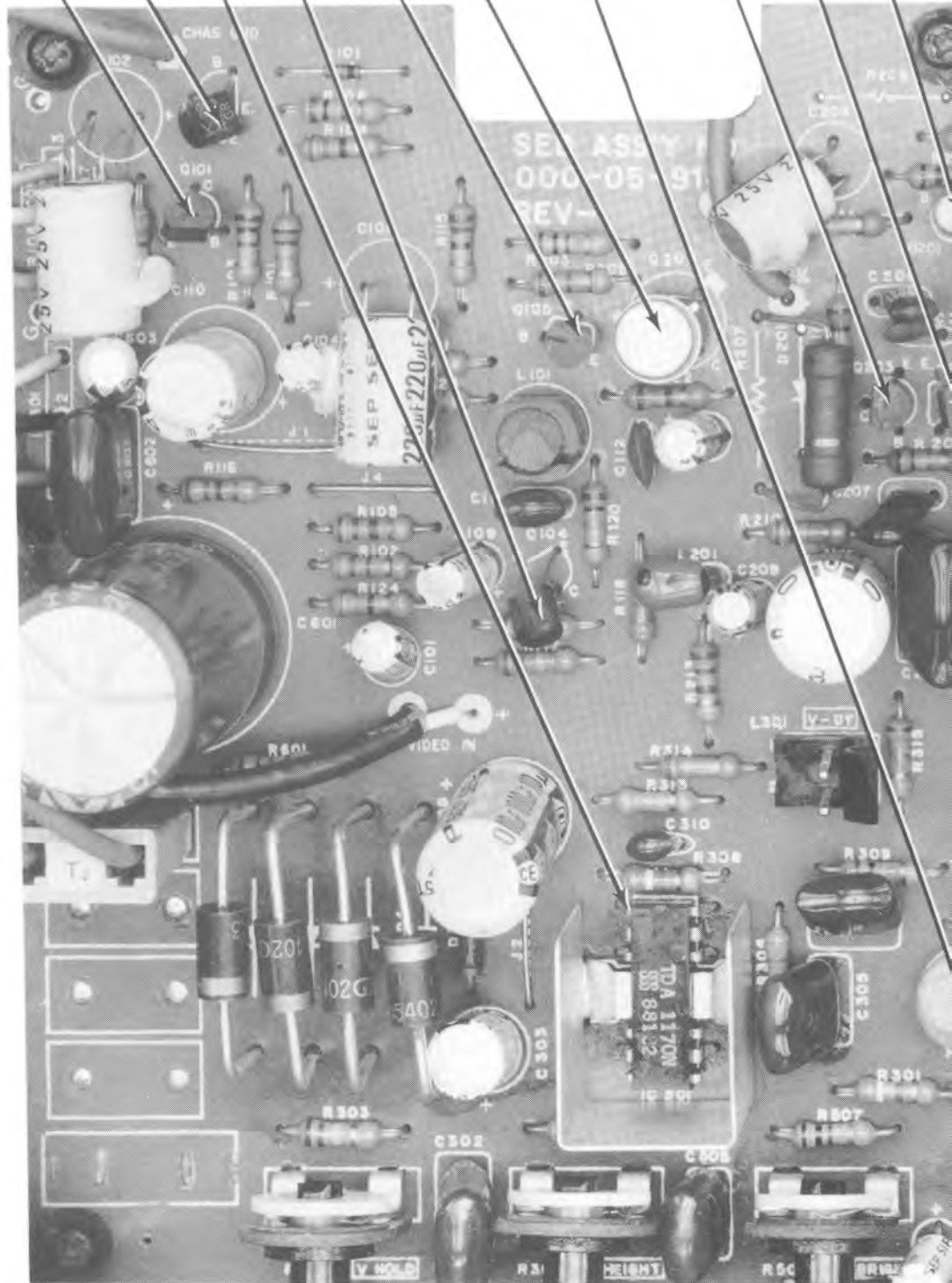

NOTE: ARROWS ON IC'S INDICATE PIN 1 UNLESS NOTED



IC401 PIN 8
HORIZ

IC401 PIN 10
VERT

Q401(B)
HORIZ

Q401(C)
HORIZ

Q401(C)
17.3V
HORIZ

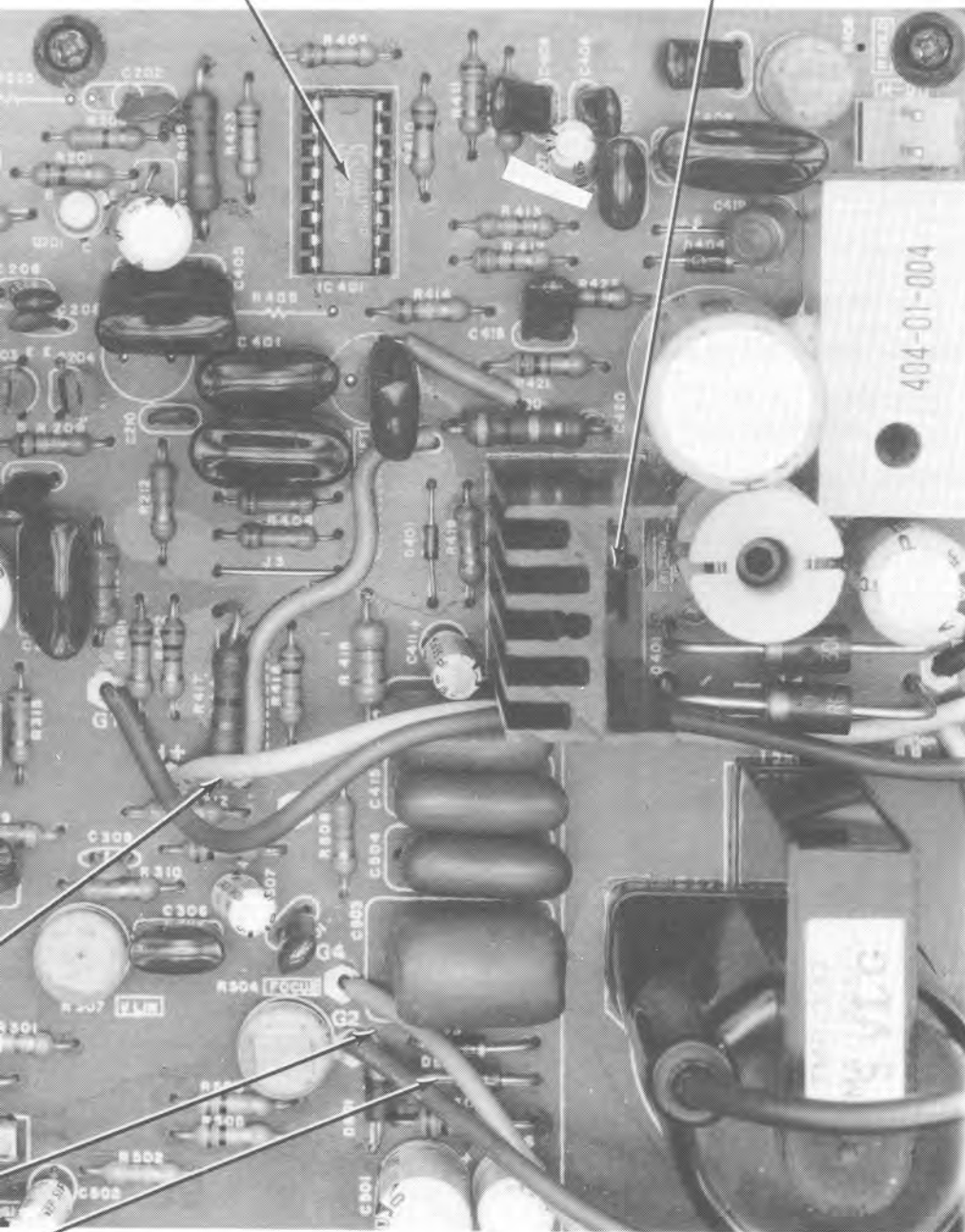

APPLE MONITOR II
MODEL A2M2010

SAFETY PRECAUTIONS

1. Use an isolation transformer for servicing.
2. Maintain AC line voltage at rated input.
3. Remove AC power from the monitor before servicing or installing electrostatically sensitive devices. Examples of typical ES devices are integrated circuits and semiconductor "chip" components.
4. Use extreme caution when handling the printed circuit boards. Some semiconductor devices can be damaged easily by static electricity. Drain off any electrostatic charge on your body by touching a known earth ground. Wear a commercially available discharging wrist strap device. This should be removed prior to applying power to the unit under test.
5. Use a grounded-tip, low voltage soldering iron.
6. Use an isolation (times 10) probe on scope.
7. Do not remove or install boards with monitor AC power On.
8. Do not use freon-propelled sprays. These can generate electrical charges sufficient to damage semiconductor devices.
9. This monitor is equipped with a grounded three-pronged AC plug. This plug must fit into a grounded AC power outlet. Do not defeat the AC plug safety feature.
10. Periodically examine the AC power cord for damaged or cracked insulation.
11. The monitor cabinet is equipped with vents to prevent heat build-up. Never block, cover, or obstruct these vents.
12. Instructions should be given, especially to children, that objects should not be dropped or pushed into the vents of the cabinet. This could cause shock or equipment damage.
13. Never expose the monitor to water. If exposed to water turn the unit off. Do not place the monitor near possible water sources.
14. Never leave the monitor unattended or plugged into the AC outlet for long periods of time. Remove AC plug from AC outlet during lightning storms.
15. Do not allow anything to rest on AC power cord.
16. Unplug AC power cord from outlet before cleaning monitor.
17. Never use liquids or aerosols directly on the monitor. Spray on cloth and then apply to the monitor cabinet. Make sure the monitor is disconnected from the AC power line.

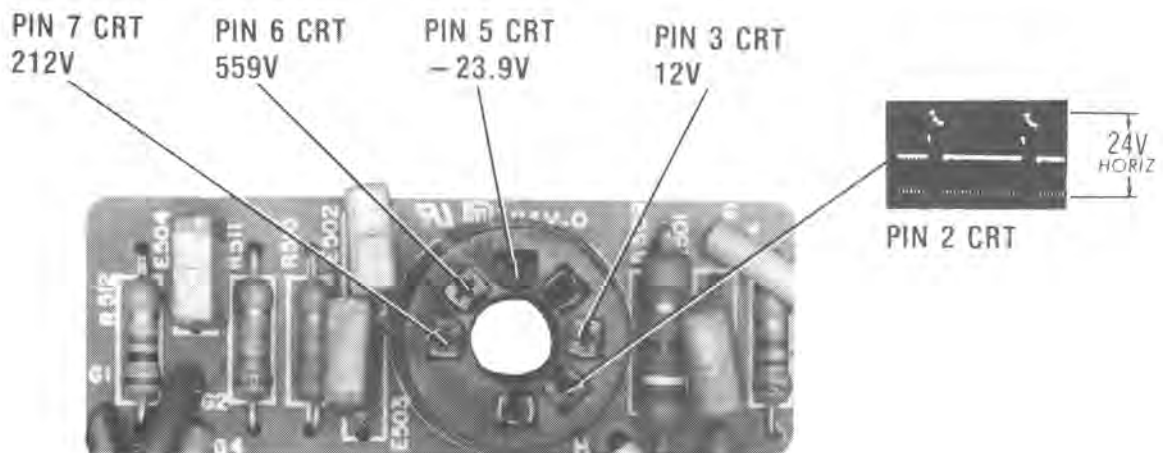

DISASSEMBLY INSTRUCTIONS

CHASSIS REMOVAL

Remove six screws holding cabinet back and remove back. Disconnect CRT socket, HV anode and ground leads. Remove six screws holding Power Indicator, Power Switch and Contrast Control to cabinet front. Disconnect yoke connector and slide chassis out of cabinet.

CRT REMOVAL

Follow "chassis removal" procedure and lay set face down on a soft protective surface. Remove four screws holding CRT to cabinet front and lift CRT out of cabinet. **Do not lift CRT by the neck.**

SERVICING IN THE FIELD

CRT IMPLOSION PROTECTION AND CLEANING

Implosion protection is an integral part of the picture tube, cleaning accomplished without CRT removal.

FUSE DEVICES

A 1-amp fuse is used for low-voltage power-supply protection.

POWER INDICATOR

Indicator is accessible after removing cabinet back.

HORIZONTAL OSCILLATOR

Adjustment of the horizontal hold is accomplished by the proper setting of the Horiz Hold Control.

WIDTH

The width may be varied by adjusting the width coil.

CENTERING

Centering is accomplished by proper adjustment of two magnetic rings located on the yoke rear cover.

IC PINOUTS & TERMINAL GUIDES

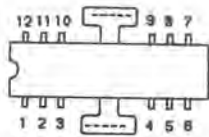

IC301
TOP VIEW

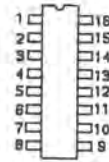

IC401
TOP VIEW

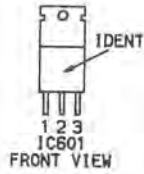

IC601
FRONT VIEW

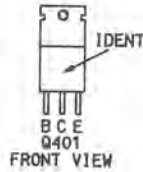

Q401
FRONT VIEW



Q101, Q102
Q104, Q105
Q203, Q204
BOTTOM VIEW



Q201
BOTTOM VIEW



Q202
BOTTOM VIEW

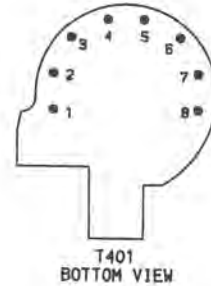

T401
BOTTOM VIEW

IC301
TDA1170N

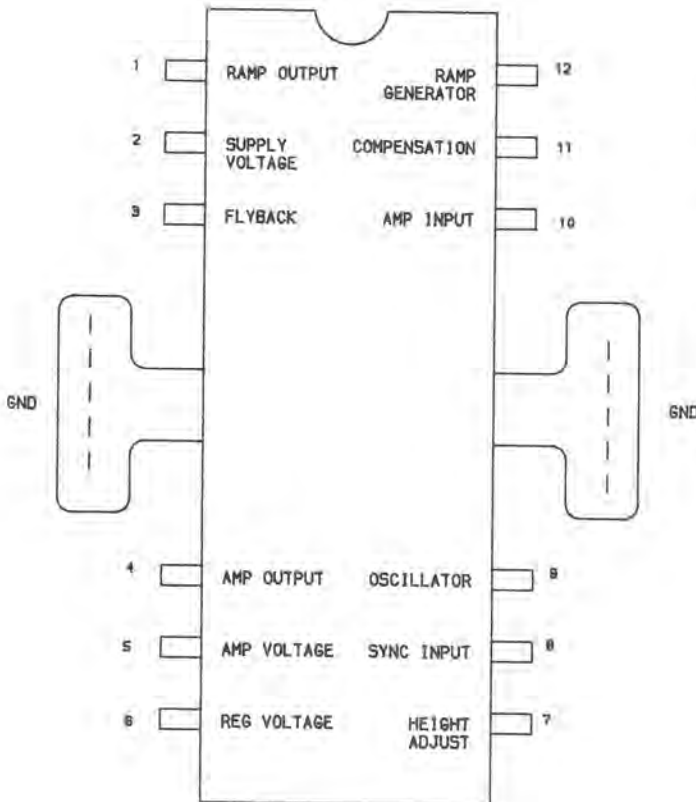

IC401
TDA1180P

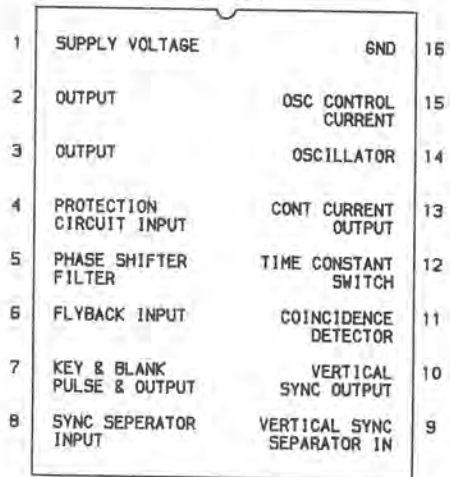

PRELIMINARY SERVICE CHECKS (Continued)

MISCELLANEOUS ADJUSTMENTS

HORIZONTAL WIDTH ADJUSTMENT

Connect a pattern generator (1VPP into 75Ω VTR Standard) to the video input and tune in a crosshatch pattern. Adjust L401 to obtain a pattern that is equal on each side and not squeezed together.

HORIZONTAL LINEARITY

Connect a pattern generator (1VPP into 75Ω VTR Standard) to the video input and tune in a crosshatch pattern. If L402 is not factory sealed, adjust to obtain proper linearity.

Note: Alternate Width and Linearity adjustments until pattern is correct.

HORIZONTAL HOLD

Connect a pattern generator (1VPP into 75Ω VTR Standard) to the video input and select a crosshatch pattern. Adjust Horizontal Hold Control (R406) until pattern locks in position. This adjustment will also eliminate tearing.

VERTICAL LINEARITY

Connect a pattern generator (1VPP into 75Ω VTR Standard) to the video input and select a crosshatch pattern. Adjust Vertical Linearity Control (R307) to make pattern even at top and bottom.

Note: Vertical Height Control can affect linearity.

PINCUSHION ADJUSTMENT

To correct Pincushion effect on the C.R.T. Raster place a magnet on the yoke mounting pin that corresponds with the affected area. Top Bow is corrected with a magnet at 0° (top center) pin. Left side Bow is corrected with a magnet at 90° clockwise pin. Bottom Low is corrected with a magnet at 180° clockwise pin. Right side Bow is corrected with a magnet at 270° clockwise pin. Rotate magnets on pin to obtain desired raster.

Note: If a second magnet is needed on any one pin the poles of the magnets must be aligned and both magnets rotated simultaneously.

TRAPEZOIDAL ADJUSTMENT

To correct a trapezoidal effect on the C.R.T. raster place a magnet on the yoke mounting pin that corresponds to the affected area. Place a magnet on the pin 45° clockwise from top center to correct top left corner. Place a magnet on the pin 135° clockwise from top center to correct bottom left corner. Place a magnet on the pin 225° clockwise from top center to correct bottom right corner. Place a magnet on the pin 315° clockwise from top center to correct top right corner. Rotate magnets to obtain desired raster.

Note: If a second magnet is needed on any one pin the poles of the magnet must be aligned and both magnets rotated simultaneously.